



D-100 and D-1000 Series Dryer

Assembly and Operating Instructions



Contents	Page#
• Safety Information	2
• General Information	3
• Package Contents	4-5
• Component Identification	6
• Assembly	7-12
• Electrical Requirements/Controls	13
• Operation	14
• Chain Drive Adjustment	15
• Warranty	16

Vastex International, Inc.
 7 Emery Street
 Bethlehem, PA 18015-1982 USA
 Phone# 610 625-2702 Fax# 610 625-2775
 Web Site www.vastex.com

Authorized Representative in Europe:
 Certification Experts BV
 Nieuwstad 100 1381 CE Weesp,
 The Netherlands
 Tel : + 31 (0) 294 – 48 33 55
 Fax : + 31 (0) 294 – 41 46 87



Watch Assembly Video Here!

Electrical Drawing #: _____ Rev: _____

Serial Number: VTX _____ Date: ___/___/___

(Please log your machine's serial number and date of purchase for future reference.)

Vastex E-mail assistance
 Purchasing, product and printing Info:
sales@vastex.com
 Electrical Support:
stech@vastex.com
 Tech Support, Mechanical Setup, and Operation:
techsupport@vastex.com

Introduction

Congratulations, you have chosen a VASTEX conveyor curing system. VASTEX has been designing and building dryers since 1960 and has the knowledge and expertise to supply a quality dryer and help you keep it running for years to come. VASTEX has innovated many of the features found in conveyor ovens today from control methods, modular features, air movements and belt tracking.

Vastex Infrared Dryer have been Factory tested and burned in for a period of 2-8 hours. All components are tested to be sure they work correctly when the Dryer leaves our factory.

Inspect all packages and notify the shipping company if any damages are detected.

Safety

The Instruction Manual and Safety Instructions must be read and understood by anyone operating the Vastex Conveyor Drying System.

- The operator should read and understand the instruction manual before operating this equipment. Store instruction manual and safety instructions near equipment for easy access to operators.
- VASTEX Conveyor Drying System is intended for the curing of non-flammable inks on screen printed materials. Do not use for any other purpose unless authorized by Vastex International, Inc. Use of this equipment for any other purpose can be dangerous and may cause damage to this equipment, voiding the warranty.
- It is recommended that the area around this equipment be designated as a work area and only authorized employees be allowed in the area.
- Children and pets must be kept clear of the work area.
- Do not place any objects on top of the drying chamber. Surfaces are hot!
- Never leave equipment unattended.
- Do not operate conveyor or dryer with any cover or guard removed.
- Operator must be familiar with controls of the dryer and conveyor.
- Never put excessive load on the conveyor belt.
- Before starting production, the operator must check that all covers and guards are in place, no material has been left on the conveyor, and the work area is clear of obstructions.
- Switch on and verify conveyor belt is moving before turning on the heat.
- Allow dryer to cool to 300°F (149°C) or turn off heat for 10 to 15 minutes before switching off conveyor.
- Always turn off power at the main disconnect at the end of production.
- In case an abnormal symptom occurs, for example excessive vibration, noise, and strong smell or smoke development, turn off the VASTEX Conveyor Curing System and contact a qualified technician.
- Immediately turn off the VASTEX Conveyor Curing System if products become jammed in the drying chamber or conveyor belt.
- Do not remove any cover or guard until power at the main disconnect is switched off and locked out. No unauthorized persons are to be allowed inside the control boxes.
- Turn off and lock out power at the main disconnect before any cleaning or maintenance.
- Only qualified technicians should be allowed to make repairs on the VASTEX Conveyor Drying System.

Stability during use, transportation, assembly, testing, and foreseeable breakdowns:

The D-100 and D-1000 dryers are designed and expected to be inherently stable under all foreseeable conditions of use, assembly, testing, etc., so long as the procedures listed in this manual are followed. Be certain that your workbench, table, or stand can safely support the weight of your ma-

Safe handling, transport, and storage:

Unplug your dryer and allow it to cool before storing. When handling or transporting your machinery, be aware of the following weights and dimensions:

D-100: Assembled — 89 lbs (40.4 kg); 46" x 24" x 24" (119 x 61 x 61 cm)

Boxes: #1 – 57 lbs (25.9 kg); #2 – 14 lbs (6.4 kg); #3 – 18 lbs (8.2 kg); Boxes on skid: 115 lbs (52.2 kg)

D-1000: Assembled — 116 lbs (52.6 kg), 46" x 32" x 24" (119 x 81 x 61 cm)

Boxes: #1 – 38 lbs (17.2 kg); #2 – 43 lbs (19.5 kg); #3 – 35 lbs (15.9 kg); Boxes on skid: 137 lbs (62.1 kg)

Safety during adjustment and maintenance

Before beginning any maintenance or adjustment procedures on your dryer:

- If the machine's heater has been ON, shut the heat control OFF, but allow the belt to continue running for 10 -15 minutes, or until the heater has cooled to 300°F (149°C) or lower . If the belt is stopped while the heater is hot, belt damage will occur.
- Switch machine OFF and disconnect from power before beginning any adjustment or maintenance.
- Do not attempt any maintenance while machine is powered.
- Do not run machine with panels or guards removed.

Adjustment and Maintenance:

- Periodically check ink temperature on garments exiting machine. See page 11, "Operation Tips." Readjust temperature control as necessary to maintain correct temperature for your application.
- Occasionally, check belt tracking and adjust if necessary. See page 9, step 12.
- Chains in chain drives can loosen over time; occasionally check the tension on the chain in your machine.

In the event of a malfunction or breakdown:

- Allow heater to cool, then shut off machine and disconnect from power as described above in "Safety during adjustment and maintenance."
- Follow the troubleshooting chart below
- If the chart does not resolve the trouble, contact Vastex for additional assistance.

Symptom	Possible Cause	Solution
No functions operate	Machine unplugged Building wiring fault	Make sure machine is plugged in. Have wiring checked.
Belt does not move	Belt circuit fuse(s) blown Speed control faulty Belt motor faulty	Check or replace fuse(s). Replace. Contact Vastex. Replace. Contact Vastex.
No heat	Faulty heater control Faulty heater assembly	Replace. Contact Vastex. Replace. Contact Vastex.

Package Contents D-100 only

3 Separate Cartons

Carton #1 Conveyor Components

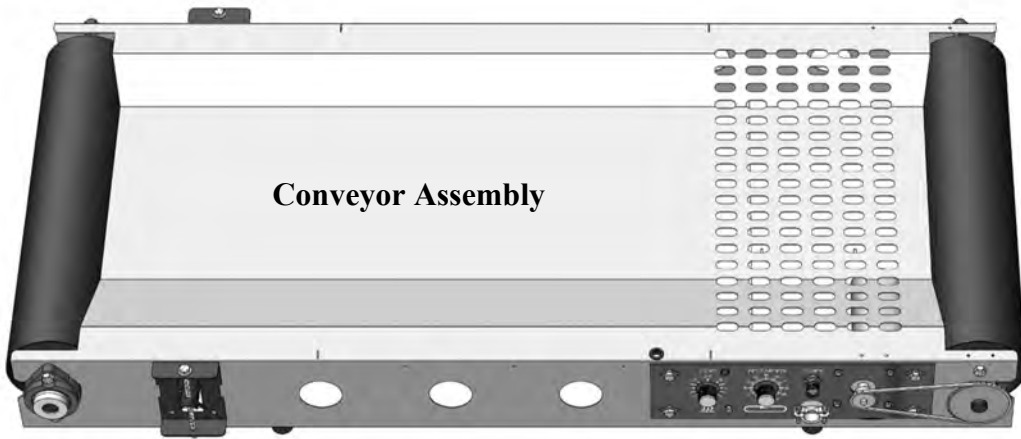

Conveyor Belt

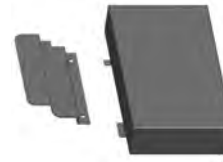

- 1) Chain Guard
- 1) Hardware package with:
6 screws and 2 belt guards.

Carton #2 16 x 16 Infrared Heater



Carton #3 Chamber Components

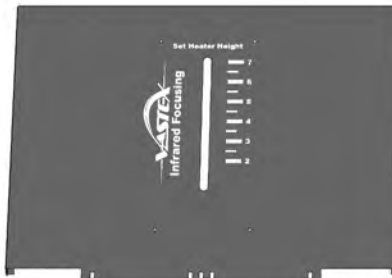

Side Panel

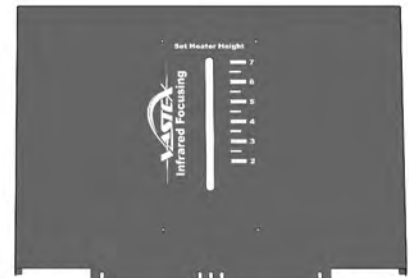

Side Panel



Back Panel



Front Panel

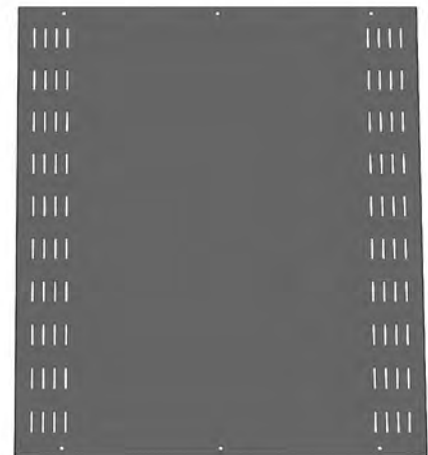

Top Cover

Hardware Package Contains

- (1) Wire Cover
- (2) Knobs
- (2) Heater Hold Down Tab
- (2) Heater Hanger Bracket
- (40) Black #8 Sheet Mtl Screws
- (1) 1/4" & 7/16" Hex Wrench



Heater Hold
Down Tabs



Knobs



Wire Cover

Package Contents D-1000 only

3 Separate Cartons

Carton #1 Front Conveyor Components

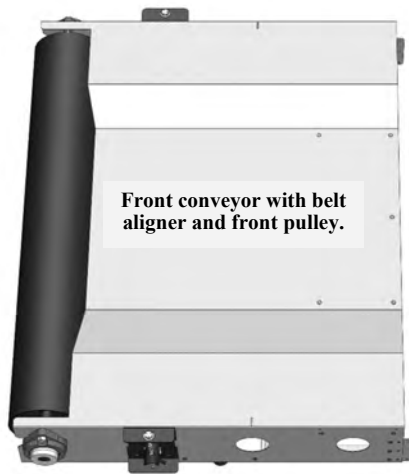

Carton #2 Rear Conveyor Components



Additional items above:
1) Belt, 1) Chain guard, and 1) Hardware package with: 6 screws and 2 belt guards.

Carton #3 Chamber and heater Components



#8 sht metal screw

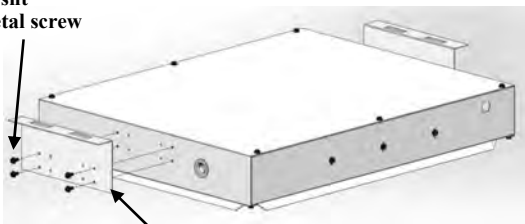

Hanger

Install hanger with provided #8 sht metal screws as shown above

Hardware Package Contains

- (1) Wire Cover
- (2) Knobs
- (2) Heater Hold Down Tab
- (2) Heater Hanger Bracket
- (40) Black #8 Sheet Mtl Screws
- (1) 1/4" & 7/16" Hex Wrench



Side Panel



Side Panel



Back Panel



Front Panel



Heater Hold Down Tabs



Knobs



Wire Cover

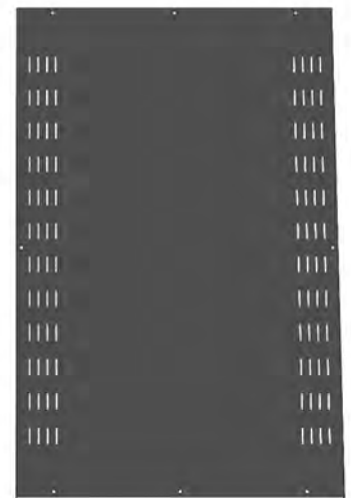

Top Cover

Component Identification

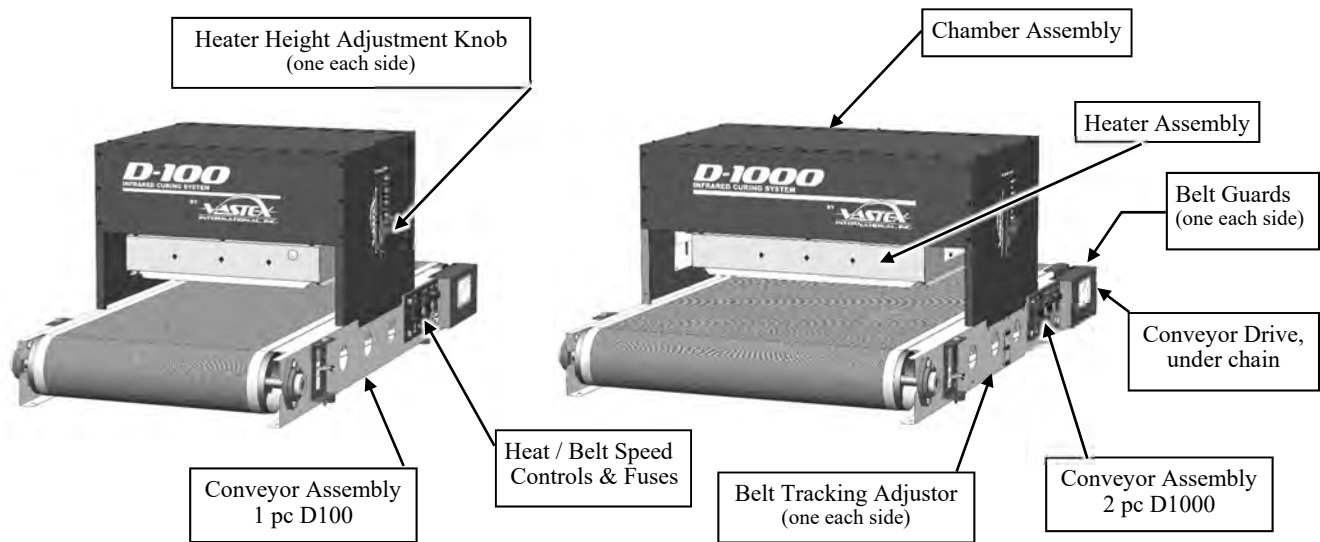

Chamber Components

IR Heater

HI-16-D100-120
HI-16-D100-240
HI-1620-D1000-120
HI-1620-D1000-240

The infrared heaters in VASTEX dryers emit medium wave infrared heat, perfect for curing many types of fabric inks. The heater height and tilt is adjusted by knobs located on the sides of the chamber. A heater height scale allows for accurate height adjustment.

Conveyor Components

Belt

D100 p/n 04-06-065
D1000 p/n 04-06-131
D1000 extension belt
p/n 04-06-132

The conveyor belt is made of Teflon coated fiberglass. It is joined together with an alligator lace using a steel pin to connect each side. The belt will not burn under normal conditions but the dryer should always have the belt moving while the heater is hot. The belt should remain tracked in the center of each pulley. (See Belt Installation and Tracking for adjustment instructions.)

Aligner

The aligner is a device for tracking the belt and keeping it on the pulley. As the belt moves from side to side the aligner is used for adjustments to keep it centered. The belt does not have to be perfectly centered on the pulley but should not be hanging over either edge.

Pulley

The pulleys at either end of the conveyor are made by VASTEX of 4 ½ inch tubing with ¾ inch center shaft. They are mounted on self aligning flange bearing blocks for precision rolling.

Gear Motor

P/N 04-02-005

A 90 Volt DC gear motor is located to the rear of the conveyor. It drives the rear pulley and belt with a roller and a #25 chain.

Belt Speed Control

P/N 04-01-004 (120V)
P/N 04-01-005 (240V)

Rotate knob clockwise to increase, counter clockwise to decrease belt speed. Turn knob counter clockwise until it clicks for off position.

Heat Control

P/N 04-01-008 (120V)
P/N 04-01-009 (240V)

Turns power on/off and varies heater temperature.

Fuses

P/N 04-03-057
(Fuse AGC 1 amp)

Protects the belt drive control circuit.
One required for 120V Dryers, two required for 240V Dryers

Assembly D1000 conveyor only

The D1000 conveyor comes in two sections. Slide them together while interlocking the joiner plates and insert six (6) screws on each side as shown below.

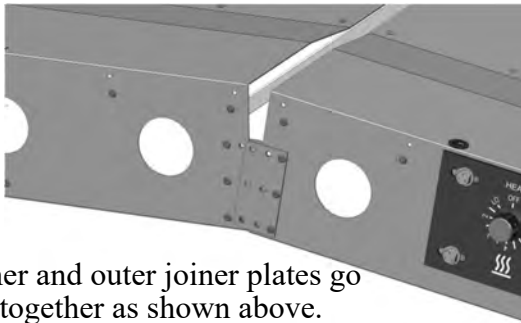

Inner and outer joiner plates go together as shown above.

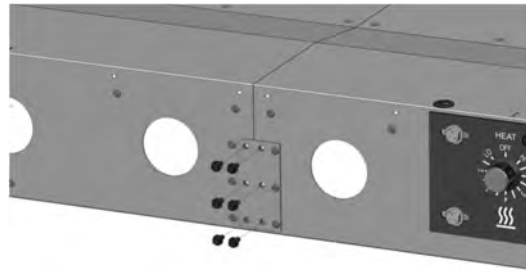

Install 6 screws on each side.

NOTE: D100 conveyor come shipped as one piece.

Optional 10" Conveyor Extension D1000

The optional D-1000 conveyor extension comes complete. Instruction for installation are as follows: Disconnect all power. Remove dryer chamber via 3 or 4 sheet metal screws on each side. Separate conveyor belt. Remove front and back halves of the conveyor via 6 screws.



Sheet metal screws (3 or 4 each side)

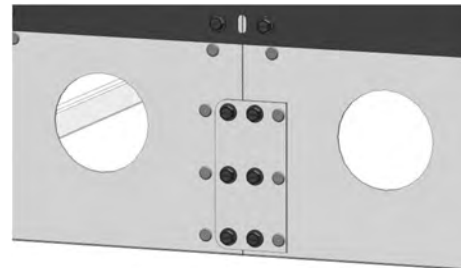

Remove 6 screws on each side.

Separate front and rear conveyor sections. Insert the 10" conveyor extension noting the position of the inner and outer joiner plates. Attach extension to front and rear conveyor section with screws provided. Splice the conveyor belt extension piece. Replace dryer chamber into conveyor via the sheet metal screws. Reconnect power.

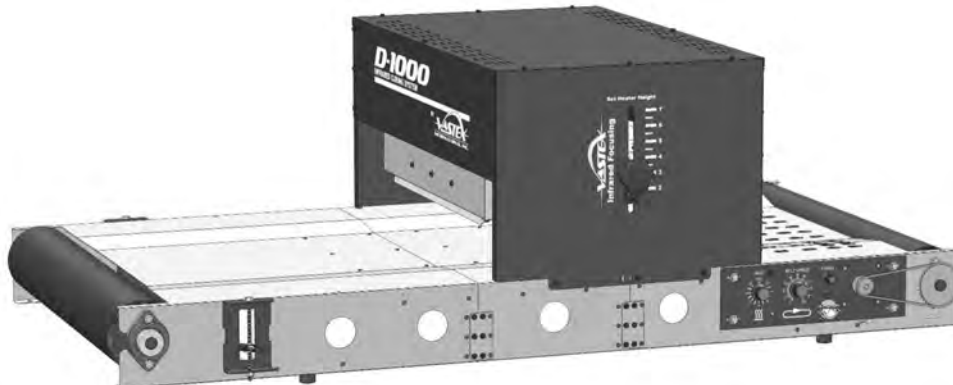

Assembly

Tools Required:

Note: A 1/4" and 7/16" Flat Plate Wrench is supplied.

Or use

1/4" Nut Driver (recommended) or 1/4" Socket and Ratchet (6.5mm)

7/16" Wrench Open End (11mm), for belt aligner adjustment.

1A) Install knob and bolt through pointer and spacer outside of both side panels. Connect to weldnut and hexnut on other side as shown above.

Chamber Assembly and Heater Installation

Do not over tighten fasteners.

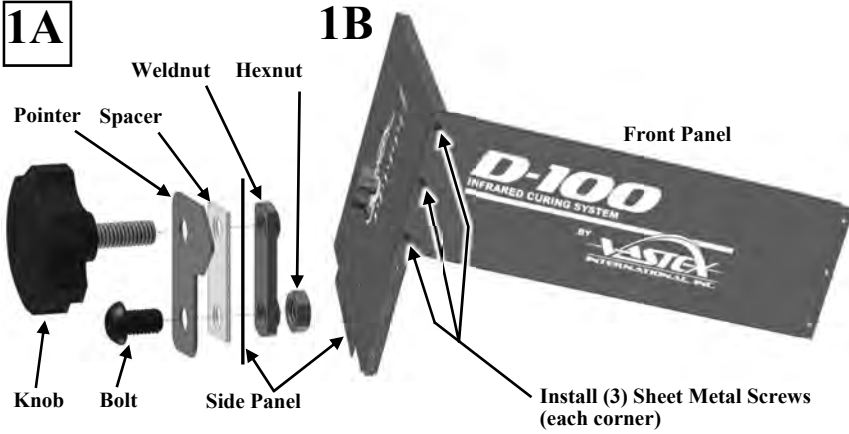

Attach Front Panel to Left Side Panel



Attach Back Panel to Left Side Panel



Attach Front & Back Panel to Right Side Panel



Heater wires are towards back of chamber

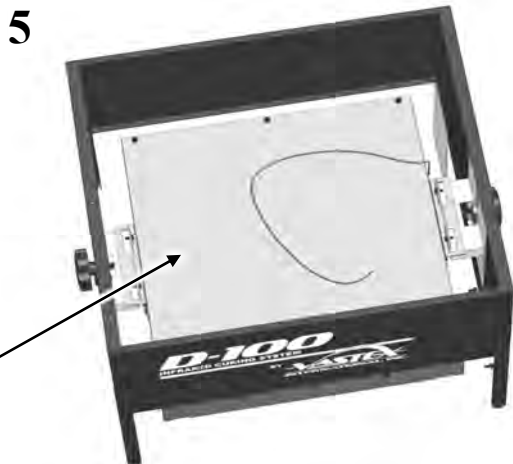

See Pg. 5 for heater assembly

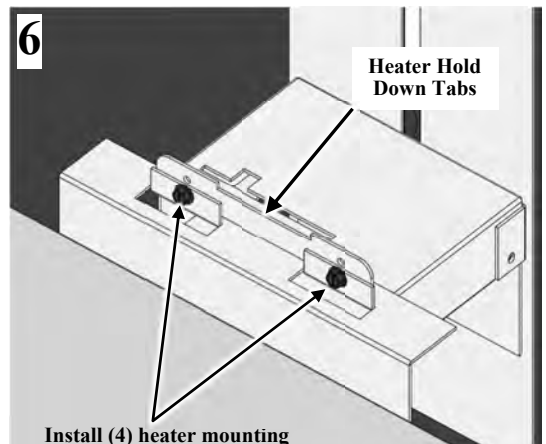

Install (4) heater mounting screws (2 each side) through the heater hold down tabs

Assembly Cont.

Connecting Chamber To Conveyor

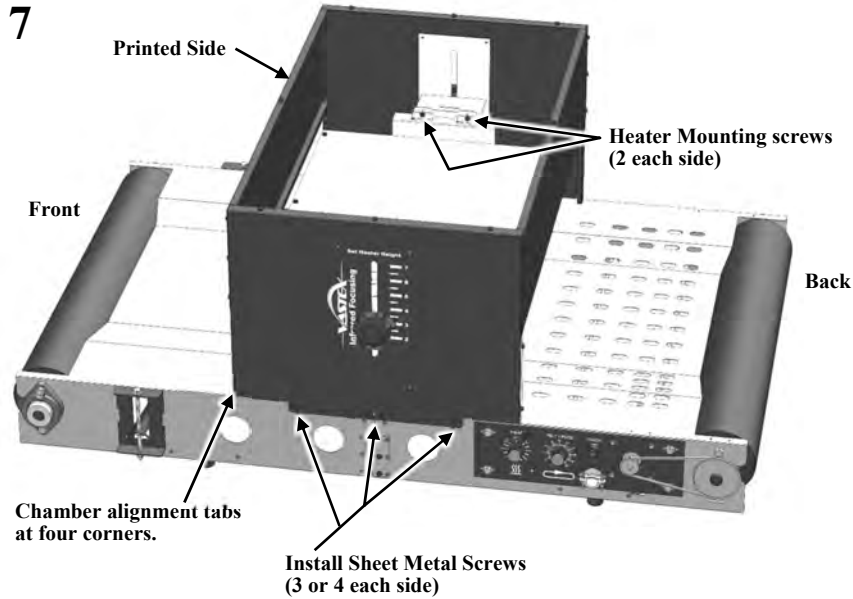

Heater and mounting pins installed, wires toward the back. Position chamber onto conveyor. Corner alignment tabs on chamber slide into cutouts in conveyor. Note heater wires are towards back of conveyor. Attach chamber to conveyor with (6) screws, 3 each side.

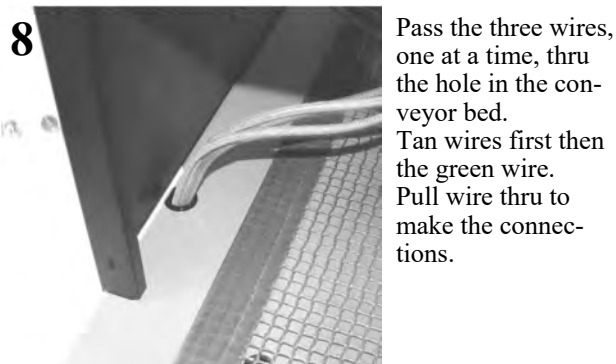

Note: Power cord must be unplugged and belt removed to make heater connections. Do not operate dryer without belt installed.

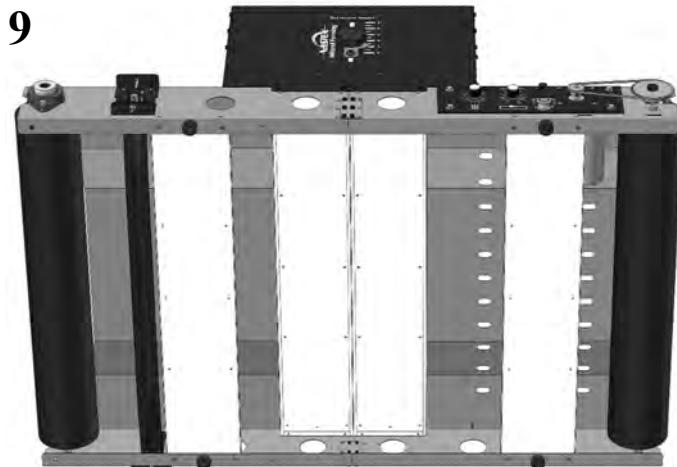

Check that the heater mounting pins are installed before proceeding. Carefully lay the conveyor on its side as shown.

Assembly

Heater Wire Connections

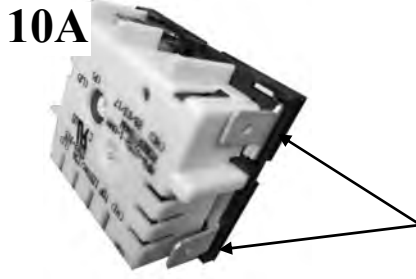

10A

See photo 10B for Ground Wire Connection

Push any extra slack in the wires, back up thru the hole in the conveyor bed.



Heater Wires (tan wires) have push on connectors. Attach either wire onto either open terminal (indicated on the left) on the heat control.

It does not matter which wire to which terminal. Align the connector with the tab on the heat control and **push firmly until fully seated**. It should be hard to push them on, we want a tight connection. Pull gently on each connector, it should be held firmly onto the tab.

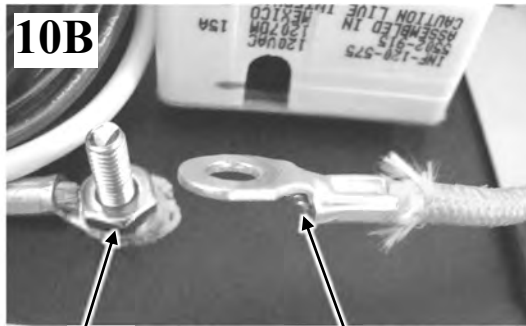

10B

Grounding Stud

Ring Terminal

10B. Ground Wire Connection

Remove the wingnut and lock washer. Place the green ground wire with the ring terminal oriented as shown, onto the grounding stud. Secure with lock washer and wingnut.

Tighten nut securely.

Belt Installation and Tracking

Belt Installation

- 1) While dryer is on its side, pass the belt over the aligner bar and both braces.
- 2) Carefully lay the dryer back onto its feet.
- 3) Align the edges of the belt and insert the belt connecting pin. See enlarged view below.
- 4) Center belt on both rollers. Raise both sides of the belt aligner equally approximately 1-1/2".

Do Not over tension belt, tension only enough to eliminate any belt slip on drive pulley.

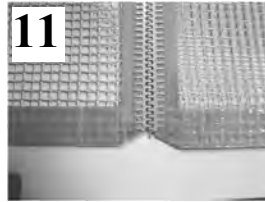

Align the edges of the belt. Insert the belt connecting pin. Pin ends can be trimmed if desired

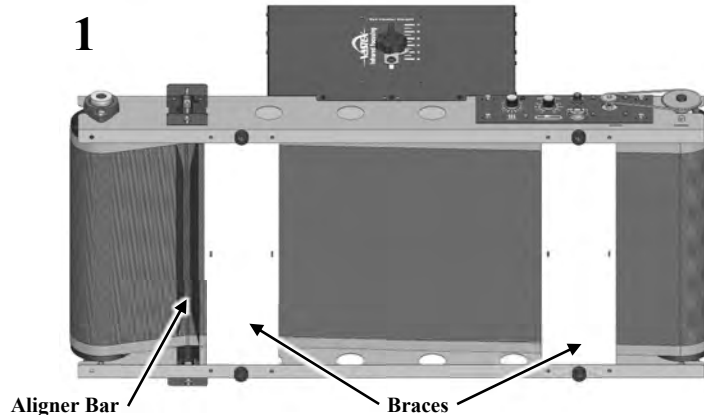

1

Aligner Bar

Braces

Assembly

12

Belt Tracking Adjuster Bolts

Left Side

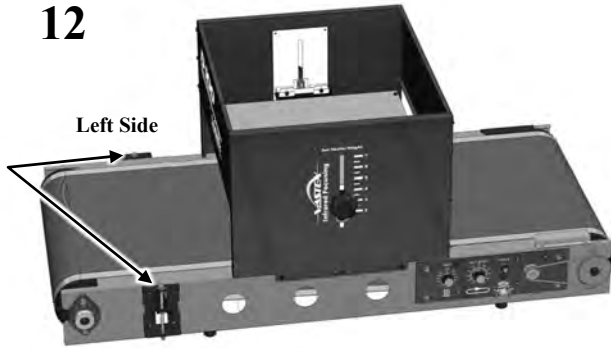

Right Side

Belt Tracking

Perform after assembly is complete and dryer is on a flat surface. Maintain belt as close to centered as possible on both rollers. Do Not leave conveyor unattended during tracking process.

- 1) While conveyor is running at full speed, observe position on both rollers.
- 2) Raising the belt aligner on one side moves the belt in the opposite direction. Lowering the bar moves the belt toward that side.
- 3) Make small adjustments, 1/4 turn of adjuster bolts. Allow the belt to respond to the adjustment.

Never allow the belt to track off the rollers, belt damage can result. Make belt tracking adjustments as needed.

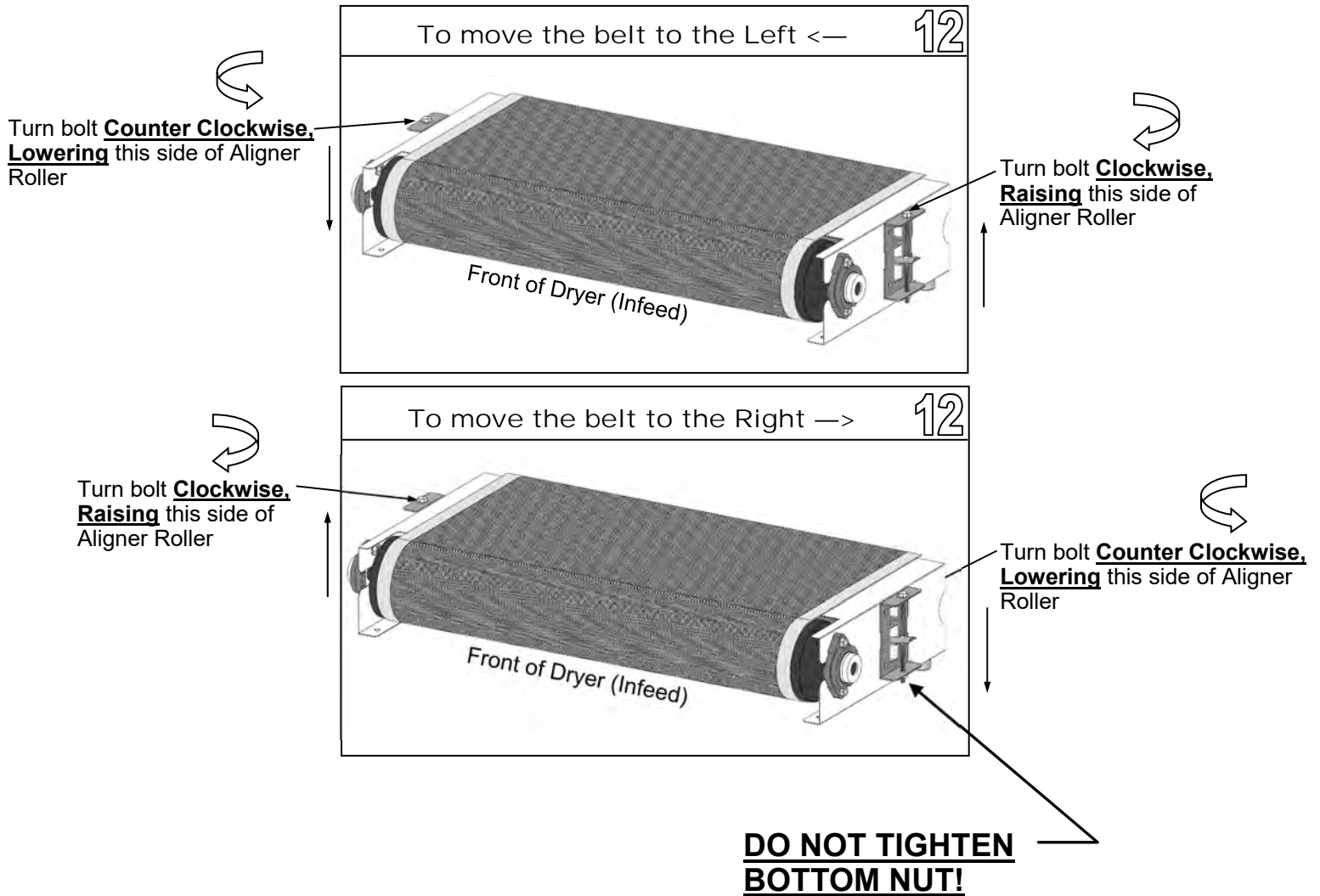

Assembly

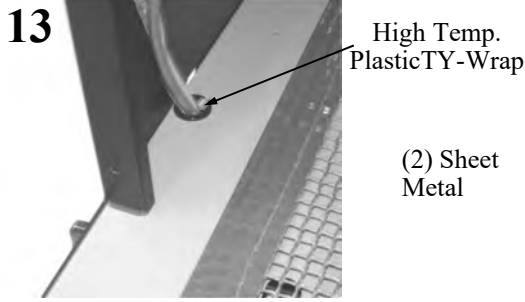

Gently pull up on wires to remove any excess wire from below the conveyor bed. Place the high temperature plastic ty-wrap as shown to control wire movement. Cut extra material off ty-wrap.

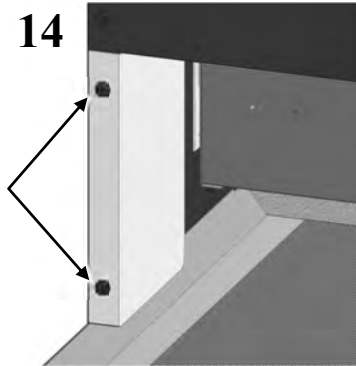

Carefully position wires behind wire cover, attach cover with (2) screws.

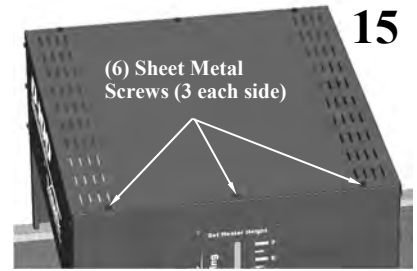

Install top cover after all heater wire connections are completed.

Installing Chain Guard and Belt Guards

Chain Guard must be installed before operating the dryer. Hook tabs on the bottom of the guard into the slots below the drive chain. Pivot the guard up, secure to the conveyor with (2) sheet metal screws.

Belt Guards are to be installed at both sides on the rear of the conveyor. Secure to conveyor with (2) sheet metal screws.

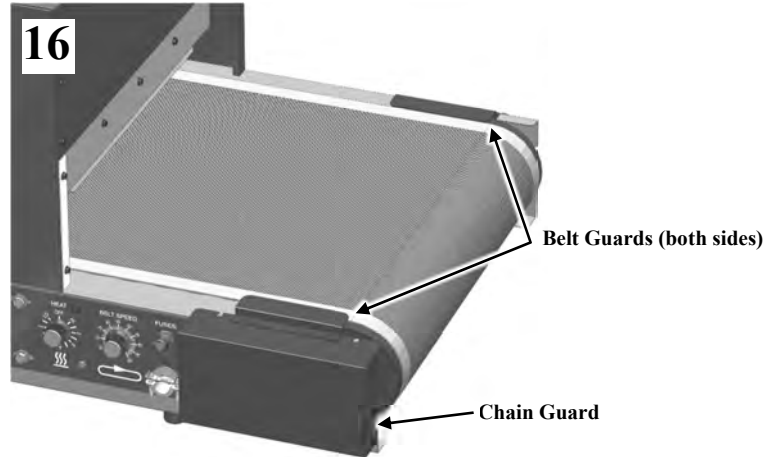

Do Not operate dryer with chain guard removed.

Electrical Requirements

Models: Plugs and receptacles listed are for domestic (USA) models. International models are supplied with the appropriate power cords.

D-100 / 120Volts, 12.5Amps, 1.63KW

Requires dedicated 15 amp circuit with a NEW commercial duty 5-15R receptacle.

D-1000 / 120Volts, 16.5Amps, 2.05KW

Requires dedicated 20 amp circuit with a NEW commercial duty 5-20R receptacle.

D-100-240 / 240Volts, 6.3 Amps, 1.63KW

D-1000-240 / 240Volts, 8.6 Amps, 2.05KW

Requires good quality 6-15R receptacle. (Some international plugs available)

(North America Standard Receptacles)

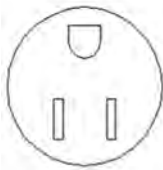

D-100
120 Volt 15 Amps
Nema 5-15R Receptacle



D-1000
120 Volt 20 Amps
Nema 5-20R Receptacle



D-100 and D-1000
240 Volt 15 Amps
Nema 6-15R Receptacle

Controls

- Variable Heat Control

The control has positions LO-2-3-4-5-6 and HI. The controller turns the power to the heater on and off to vary the temperature. The higher the number on the control the longer the on cycle and shorter the off cycle is. The "HI" position is full power.

- Heat On Light

This RED light is wired to the controller. It will illuminate when the control is turned on, even if the controller has failed.

- Belt Speed Control

Rotate clockwise to increase, counter clockwise to decrease belt speed.

- Fuses

Protects belt control circuit, (1) Amp AGC fast blow

One (1) fuse for 120 volt.

Two (2) fuses for 240 volt.



Control Plate

Dryer Operation

Startup Procedure

- 1 Plug in Dryer:** Be sure the breaker and dryer controls are switched off. Plug the dryer into a properly rated outlet and turn the breaker on.
- 2 Check belt path:** Remove any objects from the conveyor and belt.
- 3 Turn on Conveyor:** Set belt speed with the Belt Speed Control on the conveyor, near the motor.
- 4 Turn on the Heat:** Turn the Variable Heat Control dial on HI for 10-15 minutes to allow the dryer to warm up.



Curing Plastisol with infrared:

Plastisol ink can fully cure in approximately 20-30* seconds. Most inks must achieve 320°-330 F (160°-165°C) throughout to cure and fuse to the garment. The thicker the ink the hotter the top skin has to be in order to be cured completely to the garment.

Discharge or water based: (A powered exhaust is recommended)

Water based products require more time than plastisol to cure due to the fact that the water/moisture must be evaporated before the ink can cure. We have seen cure times from 50 to 90* seconds to achieve a full cure or discharge and not damage the garment. Please note as the time is increased the temperature must be decreased to protect the garment from scorching.

***Actual cure times can vary depending on conditions such as garment moisture and color, ink color, ink thickness, and environmental conditions. All three variables should be used to maximize production while insuring a proper cure.**

- 5 Set the Heat:**  With the dryer plugged in, rotate the Variable Control Timer to the desired setting. Often times, it is best to run the dryer on HI and adjust your belt speed and heater height to achieve a proper cure.
- 6 Set the Heater Height:**  Set the desired heater height for your job. On each side of the heating chamber, there is a knob to raise and lower the heater. It is recommended to run the heater height at about 2" - 3" above the garment. The heater can be run at an angle for curing non-flat sub-straights such as hats.
- 7 Set the Belt Speed:**  Rotate the Belt Speed Control Knob clockwise to increase speed and counter-clockwise to decrease it. For Plastisol inks, a good starting point is 20-25 seconds in the chamber. The dial numbers are for reference only. They do not represent seconds in the chamber.

Operation Tips

- While machine is in operation, it is necessary to have the belt moving while the heater is above 300°F (149°C).
- Allow approximately 15 minutes for dryer to reach Full temperature.
- If no garments are being run through the dryer for more than 10 minutes, it is recommended to lower the dryer heat control to "4" or lower. It will take approximately 10 minutes to return to operating temperature.
- Periodically check ink temperature at the exit of the dryer. It is recommended that you check the temperature of the ink towards the outside of the printed image.
- When checking temperature with a laser gun, shoot the ink while it is still under the heating elements.

Shut Down Procedure

- 1 Turn off Heat:** Turn the Heat Control off. Allow the heaters to cool for 10-15 minutes before shutting the conveyor off. Belt damage may result from stopping the conveyor with hot elements.
- 2 Turn off Conveyor:** Once the dryer cools down to 300°F (149°C) or lower, turn the Belt Speed down to the off position. Skip this step if leaving the conveyor belt speed set for the following shift.
- 3 Turn off Breaker:** Turn off the breaker controlling the dryers at the end of each shift and unplug them from their outlets.

— Chain Tension measured and why it is important —

The proper chain tension is critical to achieving acceptable service life as excessive tension can cause accelerated wear or chain overload and excessive slack can cause rough chain operation and possibly result in the chain skipping a sprocket tooth, resulting in a catastrophic failure. For Vastex drives, the total movement in the slack span of the chain (up and down total movement) should be .25 to .38 inch. Please see below for picture.

This is the slack in the down position.

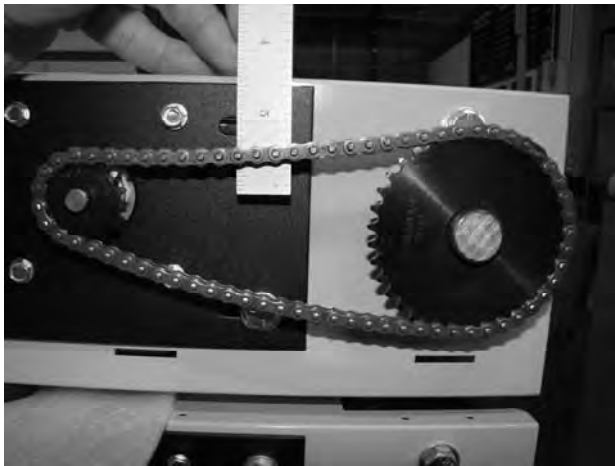

This is the slack in the up position.

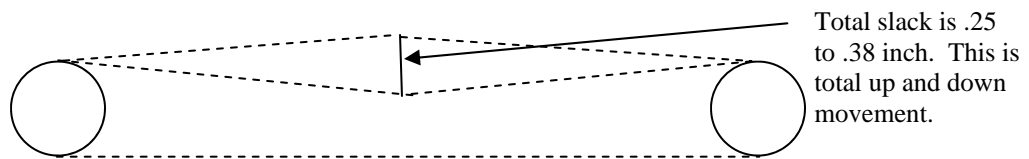
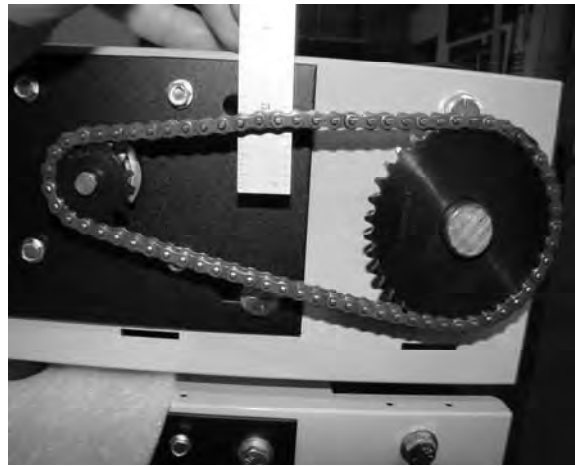

Vastex Warranty

Doc#01-00-005D Revised 2/20/2018

(1.) Vastex, hereinafter referred to as "seller" warrants only to its original "purchaser", who holds a copy of the original invoice and is the original end user of the equipment in question, its new equipment against manufacturer defects in materials or workmanship on a pro-rated basis. Warranty period begins from date of shipment to the buyer and will only apply to customers paid in full. Warranty periods are as follows: one (1) year for E-1000, three (3) years for all other complete machines (including F-Flash), fifteen (15) years for infrared heaters (excluding F-Flash) installed by Vastex in a new dryer, three (3) years for replacement infrared heaters, and one (1) year for replacement parts. Rubber blankets, light bulbs and glass on exposure units are particularly subject to wear while in use. Wear is not covered by this warranty but as stated above only manufacturers defects are covered. All sales made through Vastex dealers must be certified by that dealer before a warranty replacement is issued. All equipment is thoroughly tested and inspected before packaging. This warranty does not cover minor cosmetic damages that occur during shipment that do not affect the functionality of the equipment.

(2.) **This warranty is expressly contingent upon the buyer delivering to seller, at the address below, with all transportation charges prepaid, the part or parts claimed to be defective within the above mentioned warranty periods stated in paragraph one. The defective part or parts will be repaired or replaced at the discretion of Vastex International, Inc. If the equipment in question is less than one (1) year old, it will be shipped to the customer at no charge, with an RGA issued by Vastex for the defective part. The defective part must be shipped back to Vastex freight prepaid within 30 days or the account will be billed. If the equipment is more than a year old, the part will be shipped after we receive the defective part. If it's necessary to expedite the movement of parts and to minimize down time to the buyer, the replacement part shall be supplied on a C.O.D. basis. If testing and analysis of said part by the seller or its supplier discloses that said part is defective, the cost of said part will be refunded to the buyer on a prorated basis.**

(3.) Except as otherwise provided herein, the equipment is being sold "as-is". Final determination of the suitability of the equipment for the use contemplated by the buyer, is the sole responsibility of buyer, and seller shall have no responsibility in connection with the suitability.

(4.) All warranties implied by law, including the implied warranties of merchantability and fitness are hereby limited to manufacturer defects in materials or workmanship during the warranty period stated in paragraph one. The express warranty and remedies contained herein and such implied limited warranties are made solely to the sole warranties and remedies and are in lieu of all other warranties, guarantees, agreements, and other liabilities, whether express or implied, and all other remedies for breach of warranty or any other liability of seller, in no event shall seller be liable for consequential damages.

No person, agent, distributor, or service representative is authorized to change, modify or extend the terms hereof in any manner whatsoever.

These terms and conditions are an essential part of the transaction between the parties and constitute the entire agreement between them with respect to the same.

Some states do not allow limitation on how long an implied warranty lasts of the exclusion or limitation of incidental, or consequential damages, so the above limitation may not apply to you.

This warranty gives you specific legal rights, and you may also have other rights which vary from state to state.

Infrared heaters are the only replacement parts covered for a period of (3) years from date of shipment and contingent to receipt of payment in full.

Electrical components cannot be returned once installed unless proven defective.

Please refer to doc. 01-00-015 for specific terms and conditions of sale and the limited warranty.

Please refer to doc. 01-00-017 for V-2000HD printer warranty.

Updates: V1000 to 3 year warranty 01/09/12, Heater warranty to 15 years 01/02/2012.

TERMS AND CONDITIONS OF SALE AND LIMITED WARRANTY Doc.#01-00-015

- Buyer's order will constitute an offer in accordance with the terms hereof and such offer, upon acknowledgment of Seller, will constitute the agreement between Buyer and Seller. Buyer's order after such acknowledgment by Seller will not be subject to cancellation, change or reduction in amount, or suspension by Buyer of deliveries, unless prior to such action Buyer has obtained Seller's written consent. Notwithstanding anything to the contrary in Buyer's Purchase Order or other communications, the parties agree to be bound by these Terms and Conditions. Acceptance of the product by the Buyer shall be deemed to constitute unconditional acceptance of these Terms and Conditions.
- Any of these terms, conditions and provisions of Buyer's order which are inconsistent with Seller's acknowledgment and these Terms and Conditions of Sale shall not be binding on the Seller and shall be considered not applicable to any sale so made. No waiver, alteration or modification of any of the provisions on either side of the document shall be binding upon Seller unless agreed to in writing by Seller.
- (a) All prices are F.O.B. Seller's Plant and method of delivery and routing shall be at Seller's discretion, unless specifically otherwise stated herein. Notwithstanding any agreement to pay freight, delivery of products purchased hereunder to a common carrier or licensed trucker shall constitute delivery to Buyer and be determinative of the date and time of shipment and all risk of loss or damage in transit shall be borne by Buyer. If the Buyer fails to accept the goods from the common carrier or licensed trucker, the Seller shall be entitled to claim payment from the Buyer. Seller shall arrange for storage, the risk and the cost, including insurance costs, to be borne by the Buyer (and Buyer agrees to pay such amounts upon demand) except if the failure to accept delivery is due to any of the exceptions noted in Paragraph 4.
(b) Terms of payment shall be as stated on invoice.
- It is understood that deliveries will be made in accordance with Seller's regular production schedule. Every reasonable effort will be made to meet the Buyer's required delivery dates but Seller will not be liable for damages or be deemed to be in default by reason of any failure to deliver or delay in delivery due to any preference, priority, allocation or allotment order issued by the Government, whether Federal, State or local, or causes beyond its control including but not limited to, Acts of God or a public enemy, acts of Government, fires, floods, epidemics, quarantine restrictions, strikes, lockouts, freight embargoes, severe weather, unavailability of materials or shipping space, delays of carriers or suppliers or delays of any subcontractors. Should delay in delivery be caused by any of the circumstances mentioned in this paragraph, such extension of the delivery period shall be granted as is reasonable under the circumstances of the case. Should delay be caused by an event not specifically mentioned in this paragraph, damages will be limited to cancellation of the purchase order without penalty, and refund of any monies deposited or prepaid on the purchase order with no liability for any consequential or incidental damages.
- Seller reserves the right to increase the prices prior to Seller's acceptance of order and/or after expiration of any price quoted by Seller.
- Unless otherwise stated in writing, Seller's prices do not include sales, excise, value-added or other taxes. Consequently, in addition to the price specified herein, the amount of any present or future sales, use, excise, value-added or other tax applicable to the manufacture, sale, purchase or use of the products hereunder shall be paid by Buyer, or in lieu thereof, Buyer shall provide Seller with a valid tax exemption certificate acceptable to the taxing authorities.
- Seller reserves the right, at any time, to revoke any credit extended to Buyer because of Buyer's failure to pay for any products when due or for any other reason deemed good and sufficient by Seller and in such event, all subsequent shipments shall be paid for prior to at delivery at Seller's option.
- (a) SELLER'S LIABILITY SHALL BE LIMITED TO SELLER'S STATED SELLING PRICE PER UNIT OF ANY DEFECTIVE GOODS AND SHALL IN NO EVENT INCLUDE BUYER'S MANUFACTURING COSTS, LOST PROFITS, GOODWILL, OR ANY OTHER SPECIAL, INDIRECT, INCIDENTAL OR CONSEQUENTIAL DAMAGES, ARISING OUT OF THE AGREEMENT, THIS CONTRACT, THE SALE OF THE PRODUCTS TO THE BUYER OR THE USE OR THE PERFORMANCE OF THE PRODUCTS. Seller may at its discretion repair, replace or give the Buyer credit (pro-rated) for such defective products.
(b) Notwithstanding anything herein to the contrary, Seller shall have no liability for alleged defects with the products which are not specified in written notice from the Buyer to the Seller within thirty-six (36) months from the date of shipment of machines. Seller shall pass to Buyer any warranty received by Seller from the manufacturer of Limited Life Components, which in most cases is 12 to 18 months.
(c) Seller shall have no liability under this Limited Warranty unless Buyer has paid in full for the products. Further, this Limited Warranty is expressly contingent on Buyer's delivery to Seller, all costs prepaid, the defective part(s) within thirty-six (36) months of shipment to Buyer, together with a written statement specifying the alleged defect(s). Any replacement part(s) shall be shipped to Buyer on a C.O.D. basis.
(d) SELLER SPECIFICALLY EXCLUDES ALL WARRANTIES, EXPRESSED, IMPLIED OR OTHERWISE, EXCEPT AS STATED EXPLICITLY IN THESE TERMS AND CONDITIONS OF SALE. SELLER DISCLAIMS THE WARRANTY OF MERCHANTABILITY AND FITNESS FOR A PARTICULAR PURPOSE.
- The remedies herein reserved by Seller shall be cumulative and in addition to any other legal remedies. No waiver of a breach of any portion of this contract shall constitute a waiver of continuing or future breach of such provision or of any other provisions hereof.
- These Terms and Conditions constitute the entire agreement of the parties. No amendments, changes, revisions or discharges hereof in whole or in part shall have any force or effect unless set forth in writing and signed by the parties hereto. This contract shall not be assignable by Buyer voluntarily by operation of law or otherwise without Seller's written consent.
- This contract shall be governed and shall be construed according to the domestic laws of the Commonwealth of Pennsylvania.
- Anything herein to the contrary notwithstanding, any action for alleged breach by Seller of the contract between the parties, including but not limited to any action for breach of the warranties herein set forth, shall be barred unless commenced by Buyer within one (1) year from the date such cause of action accrued.
- This agreement shall inure to the benefit of and be binding upon the parties hereto, their respective successors and permitted assigns.
- All notices required by this contract to be given by either party shall be sent in writing or by facsimile and shall be addressed to the last known address of such other party. Notices shall be deemed to have been received on the fifth business day following deposit in the mail.**